



ELOTECH
INDUSTRIELELEKTRONIK

Wilmod
heating & systems

A4000

Indicator with 4, 8 or 16* zones

* With the extension module R4010 up to 16 zones can be connected.

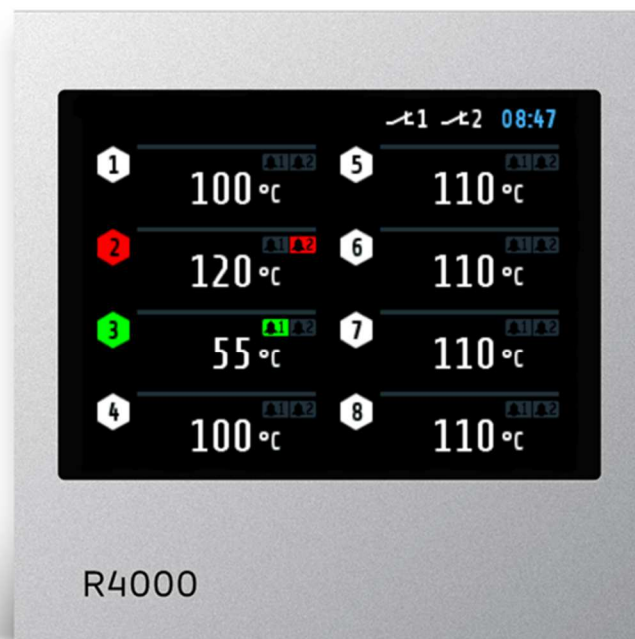

Depth: 122mm
Format: 96mm x 96mm

DESCRIPTION AND OPERATING MANUAL

ELOTECH Industrieelektronik GmbH
Verbindungsstraße 27
D - 40723 HILDEN
FON +49 2103 / 255 97 0 FAX +49 2103 / 255 97 29
www.elotech.de Email: info@elotech.de

Contents

Contents.....	2
1 General Information	3
2 Installation Instructions	3
3 Type Code	4
4 Connection Diagram	5
4.1 Connection Diagram: Power supply, Logic Inputs and Heater Current	5
4.2 Connection Diagram: Monitoring Relay	6
4.3 Connection Diagram: Sensor Inputs	6
4.4 Connection Diagram: Logic Outputs	6
4.5 Connection Diagram: Relay Outputs	7
4.6 Connection diagram Continuous outputs (option)	7
4.7 Connection diagram E-Bus for extension module	7
4.8 Connection Diagram: Fieldbus Interfaces	8
4.9 Connection Diagram: LAN and USB	8
5 Display and Keyboard	9
5.1 Window-Overview	9
5.2 Display screens (Windows)	10
5.2.1 Window: Actual Process Values	10
5.2.2 Window: Main	11
5.2.3 Window: Zone synopsis	12
5.2.4 Window: Monitoring display	13
5.3 Adjusting windows	14
5.3.1 Window: Entering number value	14
5.3.2 Window: Selection with tiles	15
5.3.3 Window: Selection List view	15
5.3.4 Window: Saving to multiple zones	16
5.3.5 Window: Setting text	16
5.4 More display screens (more Windows)	17
5.4.1 Window: Process	17
5.4.2 Window: Graph	17
5.4.3 Window: Log (Logbook)	18
5.4.4 Window: Parameter	19
5.4.5 Zone – Parameter list	19
5.4.5.1 Menu: Limit values	19
5.4.5.2 Menu: Sensor settings	20
5.4.5.3 Control outputs	21
5.4.6 Window: Tools	21
5.4.6.1 Configuration Monitoring 1+2	22
5.4.6.2 Configuration Limit 1+2	23
5.4.6.3 Field Bus / USB / LAN	24
5.4.7 Wizard	27
5.4.8 Window: System	27
5.4.8.1 Settings	28
5.4.8.2 About / → Firmware update	29
5.4.8.3 Configuration Units	29
5.4.8.4 Configuration sensors	30
5.4.8.5 Configuration Output digital	30
5.4.8.6 Configuration Output relay	30
5.4.8.7 Configuration of continuous outputs (option)	31
6 Error Messages	32
7 Technical Data	33

1 General Information

Symbols used:

www.elotech.de	Messages shown by the indicator are written in this font.
MRS / MRE	Measuring Range Start / Measuring Range End
<§>	Symbolizes the factory adjustment of the respective parameters.

2 Installation Instructions

Make sure the device is used for the intended purpose only.

A4000 indicators are designed for installation in control panels.

Protect the device against impermissible humidity and contamination.

The permitted ambient temperature range may not be exceeded.

Electrical connections must be made according to valid regulations and by properly qualified personnel.

If using thermocouple sensors, compensation lines have to be connected directly to the indicator terminals. Sensors may be connected only in compliance with the programmed range.

Sensor cables and signal lines (e.g. logic or linear voltage outputs) must be laid separately from control lines and mains voltage supply cables (power cables).

In order to maintain CE-Compliance screened detectors - and signal lines have to be used. It is not permitted to connect the grounds of the sensor-inputs and logic-outputs with each other.

Separate installation of indicator and inductive loads is recommended.

Interference from contactor coils must be suppressed by connecting adapted RC-combinations parallel to the coils.

Control circuits (e.g. for contactors) should not be connected to the mains power supply terminals of the indicator.

The configuration parameters (Window: System) are generally to be selected first.

Disclaimer of Liability

The contents of this document is checked for the conformity with the hardware and software described. Nevertheless, we are unable to preclude the possibility of deviations so that we are unable to assume warranty for full compliance. However, the information given in the publication is reviewed regularly. Necessary amendments are incorporated in the following editions.

We would be pleased to receive any improvement proposals which you may have.

The information contained herein is subject to change without notice.

Electronic scrap and components are subject to special treatment and must be disposed of by authorised companies.



3 Type Code

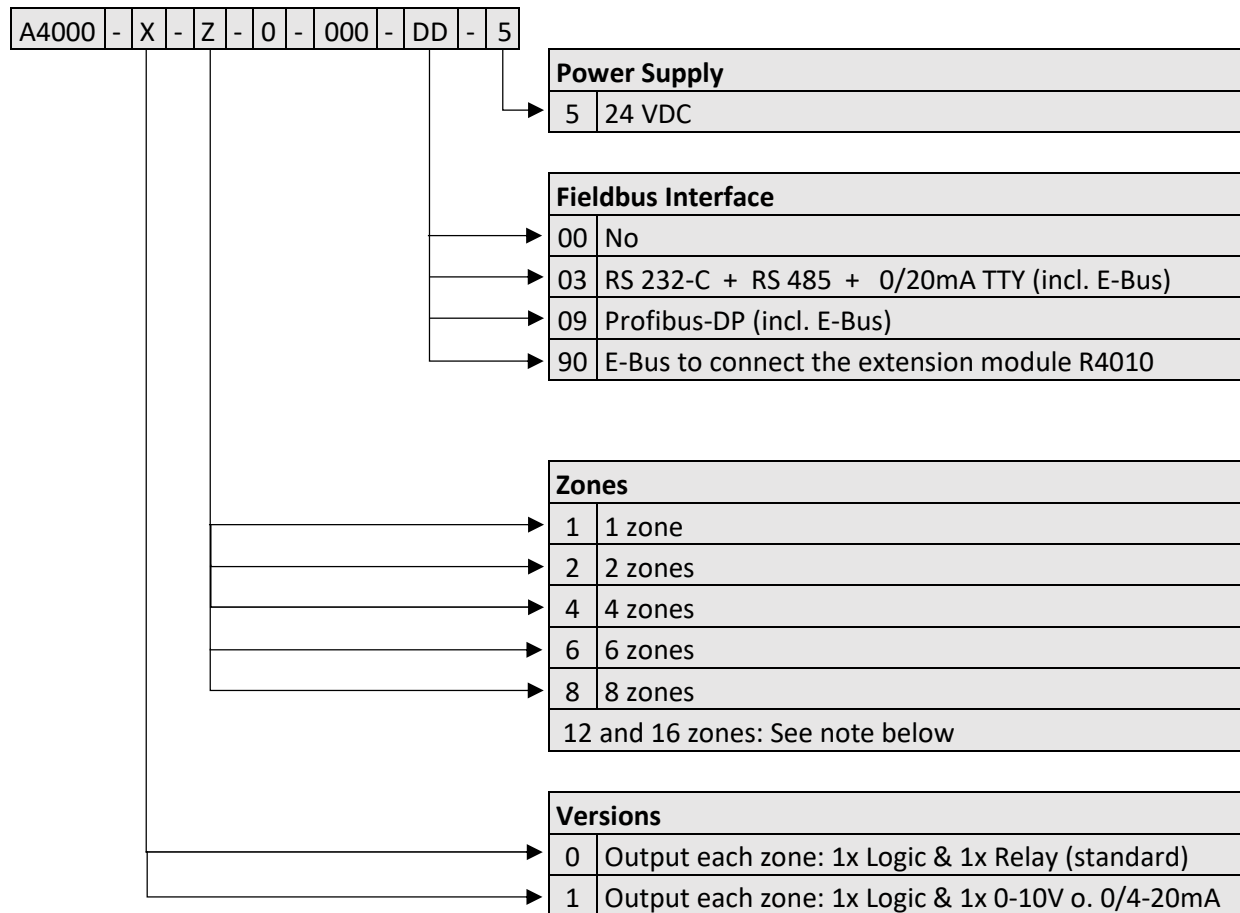

DD If 12 or 16 zones are required, an 8-zone indicator and an expansion module R4010 (4 or 8 zones) must be ordered.

The E-bus on the A4000 is required for communication with the R4010.

If the required indicator already has a fieldbus interface, then the E-bus interface is already available.

If no fieldbus interface is required, key 90 (E-bus) must be selected for the fieldbus.

4 Connection Diagram

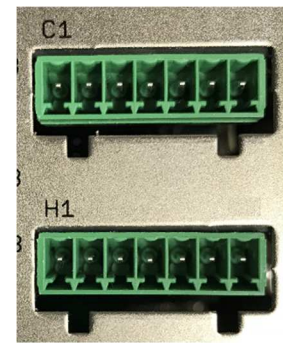
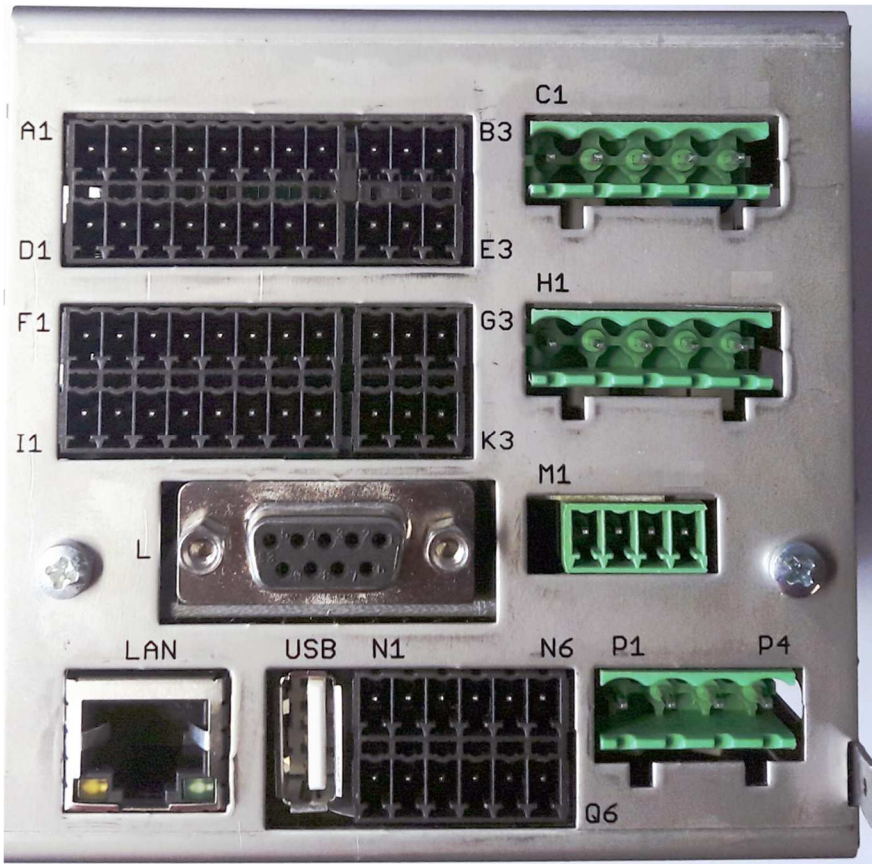

Option continuous

Ground connection

The Ground connection (flat plug 6,3mm) must be connected to an earth rail via a thick cable ($\geq 4\text{mm}^2$) in the shortest possible way ($< 20\text{cm}$)!

4.1 Connection Diagram: Power supply, Logic Inputs and Heater Current

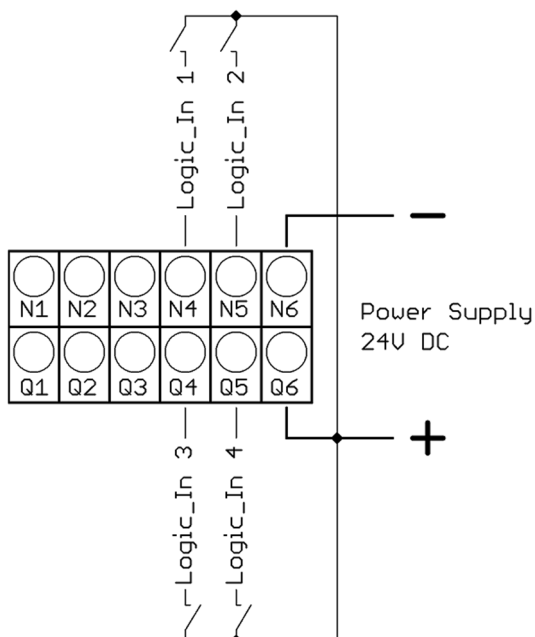

Function of the logic inputs:

In_1: no function

In_2: 0 = Parameter "Authorisation" is adjustable.
1 = Parameter "Authorisation" is not adjustable.

In_3: no function

In_4: no function

4.2 Connection Diagram: Monitoring Relay

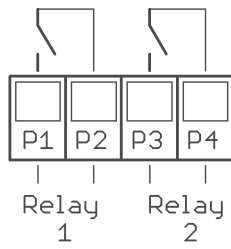

4.3 Connection Diagram: Sensor Inputs

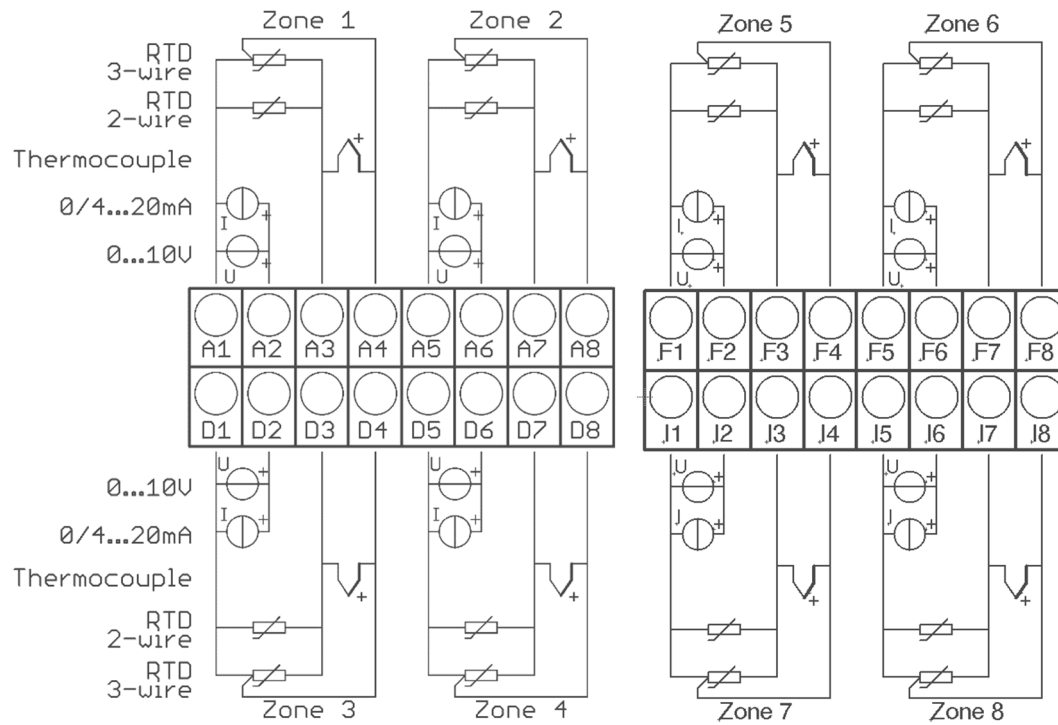

It is not permitted to connect the grounds of the sensor-inputs and logic-outputs with each other!

RTD/Ni120: The parameter "Sensor Settings / Sensor" has to be set accordingly to the connection diagram (2-wire/3-wire)

4.4 Connection Diagram: Logic Outputs

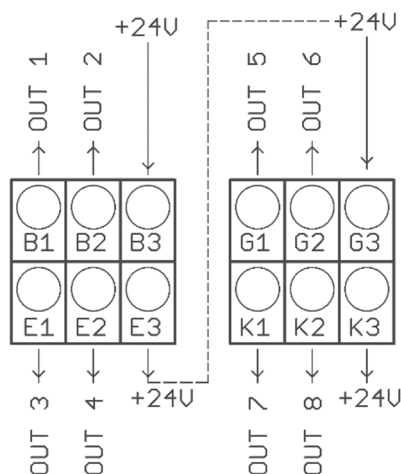

The power supply for the logic outputs has to be wired externally:

+24V have to be applied to the terminals B3 and G3.

B3 is connected internally to E3 and G3 is connected to K3. So the terminals E3 and K3 can be used to loop the +24V.

The 24V are switched to the outputs out x and thus control the SSRs. Reference potential is the ground of the supply voltage.

4.5 Connection Diagram: Relay Outputs

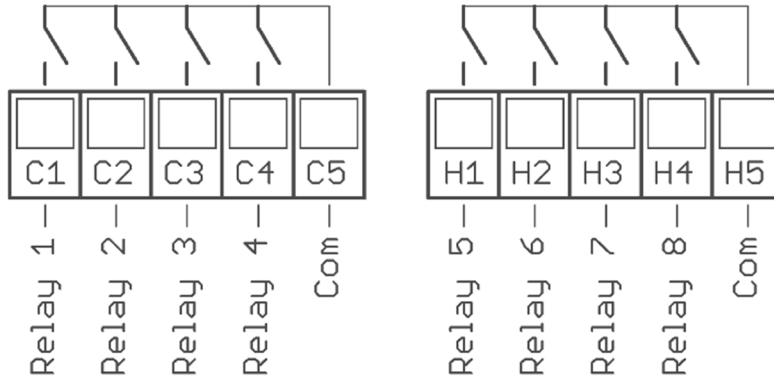

4.6 Connection diagram Continuous outputs (option)

If continuous outputs are existed, the relay outputs are not available.

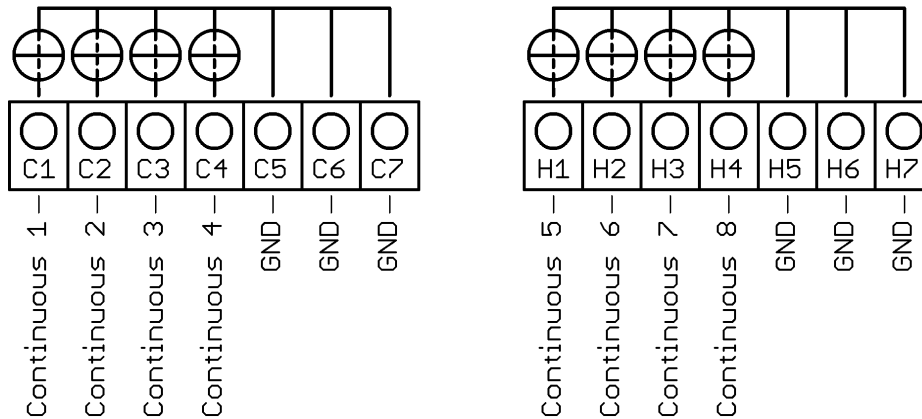

The GND connection terminals C5 - C7 and H5 - H7 are bridged. The output automatically switches to current or voltage, depending on the connected load.

4.7 Connection diagram E-Bus for extension module

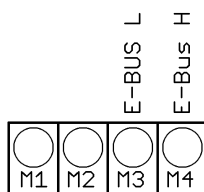

The extension module R4010, for extension to 12 or 16 zones, is connected to the A4000 via the E-bus.

The lines „E-Bus L” and E-Bus H” must be connected to the corresponding terminals of the R4010.

The connection must be designed as a shielded cable. The shield has to be connected to the earth (housing) at the R4010 side.

4.8 Connection Diagram: Fieldbus Interfaces

Type 03 / 07 : Serial Interface / CAN

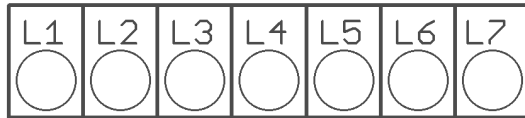

							Bus	Type	Remark
	A	B					RS485	03	Parameter HW-config = RS232 / RS485
			RxD	TxD	GND		RS232	03	Parameter HW-config = RS232 / RS485
					-	+	TTY	03	Parameter HW-config = TTY (current loop)
	H	L					CAN	07	Not available at the moment

The serial fieldbus module (Type: 03) contains the three interfaces RS232, RS485 und TTY. By choosing the connection and setting the parameter "HW-config" the desired bus is selected.

Typ 09: Profibus

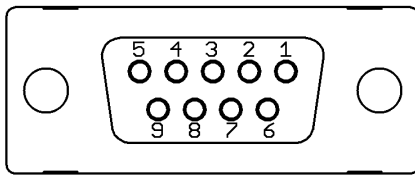

Pin 3	Data RxD / TxD - P
Pin 5	GND
Pin 6	+5V
Pin 8	Data RxD / TxD - N

The 5V-Supply is designed for the supply of the termination resistors. Further loads are not allowed.

4.9 Connection Diagram: LAN and USB

USB: Save process data, configuration data and alarm data on an USB-Stick.
Write back configuration data from USB-Stick to the indicator.
Make a firmware update. (Please use FAT formatted USB flash drives.)

LAN: Connection to configuration tool **EloVision 3**.
Read and write parameters by MODBUS-TCP protocol.

5 Display and Keyboard

The device is equipped with a backlight colour LC-display.

After switching on the indicator and completion of the initialization, the actual process values of all connected zones are displayed.

The device is operated by menus. The different parameters are displayed mainly in plain text and can be displayed in various languages.

There are several windows for different functions and settings.

5.1 Window-Overview

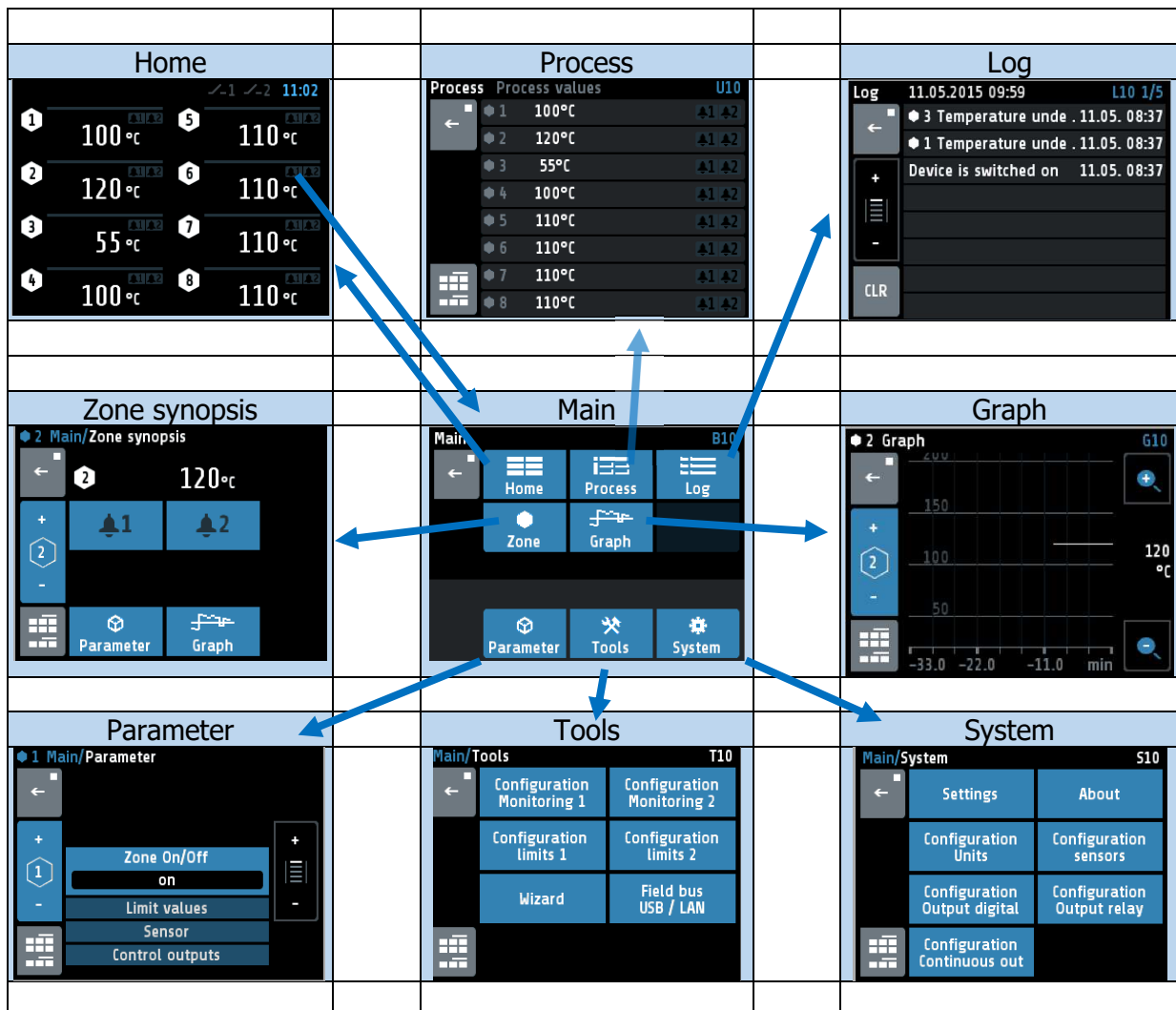

5.2 Display screens (Windows)

5.2.1 Window: Actual Process Values

Display of setpoints and actual process values of all connected zones.

	<p>The top right shows the time.</p> <p>The hexagon displays the zone number. If the zone is turned off, the actual process value displays "OFF", and the hexagon showing the number of the zone is grey.</p> <p>8-zone-indicator: For every zone the actual process value is displayed.</p>
	<p>4-zone- indicator: For every zone the actual process value is displayed.</p>
	<p>16-zone indicator: (in conjunction with 16-zone expansion module) The structure is similar to the picture of the 8-zone indicator.</p> <p>Below the zones are 2 buttons (+ / -) for switching the zones (1 ... 8) to (9 ... 16) and back.</p>
	<p>Zone 4 is set to the unit bar. Monitoring 1 is active.</p>
	<p>Contact of Monitoring relay 1 is closed. Contact of Monitoring relay 2 is open.</p>
	<p>Tapping the area of the zone, here zone 2, leads to the main menu. A grey frame and blue zone symbols show up while pressing the key.</p>

5.2.2 Window: Main

This window contains a summary of the other function windows.

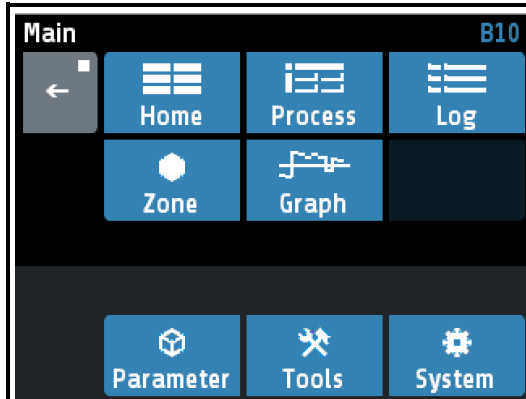









One gets to this window by pressing the area of a selected zone in the window "Actual Process Value".

Likewise, you come into this window by pressing the following icon.







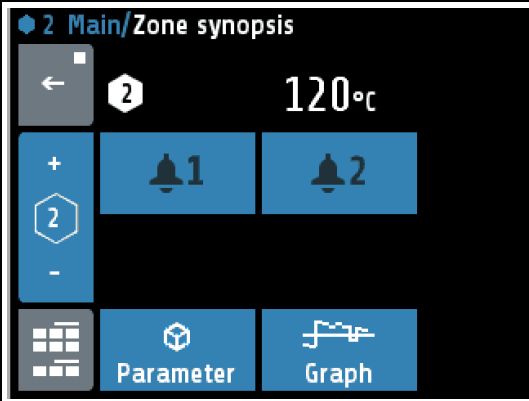

In different windows this symbol appears in the lower left corner.

	Jump to window "Actual Process Value" Display for all zones: Actual process value, alarms
	Jump to window "Zone synopsis" Display and entry for selected zone: Actual process value, monitoring state
	Jump to window "Process" (List view) Display for all zones: Actual process value, monitoring state
	Jump to window "Graph" Display for selected zone: Graphical display of the actual value process-temperature over time
	Jump to window "Log" Display for all zones: Alarm- und status messages
	Jump to window "Parameter" Display and entry for all zones: All zone-parameter
	Jump to window "Tools" Configuration of the monitoring, the alarms and interfaces. (USB, Fieldbus, LAN) Calling of the Wizard (set-up assistance)
	Jump to window "System" Configuration inputs, outputs, and unit. Setting language, date, sample time and restart lock-out.
	Hold down < 2 sec. = Return to previous window Hold down > 2 sec. = Jump to window "Actual Process Value"

5.2.3 Window: Zone synopsis

This window contains the most important information of the selected zone.

	<p>In the header the currently selected zone is shown.</p> <p>Underneath the actual process value is displayed.</p> <p>The status of the two monitoring outputs is indicated by the bell symbols.</p>
	<p>Display of monitoring 1. Grey = signal not active. Colored = signal active Pressing the area leads to the window "Monitoring display". The same applies to monitoring 2.</p>
	<p>"+" switchover to the next zone. Display of the current zone number " - " switchover to the previous zone.</p>
	<p>Jump to window "Main"</p>
	<p>Jump to window "Parameter"</p>
	<p>Jump to window "Graph"</p>

5.2.4 Window: Monitoring display

	<p>In the header the currently selected zone is shown.</p> <p>The key "configuration Moni x / Alarm" leads to the configuration of monitoring and alarms. See chapter 0</p> <p>The key "Log" leads to the alarm logbook for further information regarding the occurred alarms</p>
	<p>The light blue background and the coloured frame shows that the event "Limit 1 exceeded" has triggered the monitoring. In case the event needs an acknowledgement, it must be done by pressing the button.</p>
	<p>The dark blue background shows that the event "Sensor error" is programmed for triggering the monitoring. The event is not active.</p>
	<p>The dark grey background shows that the event "System error" is not programmed for triggering the monitoring. In case of a system error the monitoring will not be active.</p>
	<p>"+" switchover to the next zone. Display of the current zone number "-" switchover to the previous zone.</p>
	<p>Jump to window "Main"</p>
	<p>Return to previous window</p>

5.3 Adjusting windows

5.3.1 Window: Entering number value

This window helps entering number values, here for the setpoint 1.

	<p>The header displays the current zone and the name of the Parameter, here "Setpoint 1".</p> <p>By pressing the number keys the value of the parameters can be entered. In order to take over the parameter value, it must be saved by pressing the "SAVE"- key.</p>
	<p>The value, entered by pressing the number keys, is now displayed within the blue frame.</p> <p>Underneath, on the left the unit is shown and the previous value is displayed on the right (250). The allowed range is displayed at the bottom (0..800).</p>
	<p>If this Button is visible, two adjustable parameters are available. Such as: Setpoint: 1 / 2 or Ramp: rising / falling Switch over by pressing this button. The name of the actual parameter is displayed in the header. After adjusting one parameter the window will not be closed and the second parameter can be adjusted.</p>
	<p>This key is visible when the parameter has a valid value "OFF". "OFF" can be selected like a number key.</p>
	<p>Number key</p>
	<p>Key to enter "Minus" or "Comma". The minus sign can be pressed before entering a number. After the first number was entered the key automatically changes to comma.</p>
	<p>Delete last character</p>
	<p>Return to previous window</p>
	<p>Saving of what has been entered and return to previous window. By pressing "SAVE" for > 2s., a selection window appears, in which parameter values can be saved for other zones simultaneously. See 5.3.4 Window: Saving to multiple zones.</p>

5.3.2 Window: Selection with tiles

	<p>The header displays the zone number and the parameter name on the left, here "Zone On/Off".</p> <p>By pressing the tile key, the element can be selected. Black text on a white background is used to display the selected element.</p> <p>In order to save the parameter value, the "SAVE"-key needs to be pressed.</p>
	Selected element.
	Not selected element.
	<p>"+" switchover to the next zone. Display of the current zone number "-" switchover to the previous zone.</p>
	<p>Saving of selection and return to previous window. When pressing "SAVE" for >2s a selection window opens up, in which the parameter value can be saved onto other zones simultaneously. See 5.3.4 Window: Saving to multiple zones</p>
	Return to previous window

5.3.3 Window: Selection List view

	<p>The header displays the zone and the parameter name, here "Zone On/Off".</p> <p>The actual value is displayed in the middle with light blue background. By pressing the +/- Buttons on the right (or pressing the upper or lower areas of the list) the list can slide up or down.</p> <p>In order to save the parameter value, the "SAVE"-key needs to be pressed.</p>
	<p>"+" switchover to the next zone. Display of the current zone number " - " switchover to the previous zone.</p>
	<p>Saving of selection and return to previous window When pressing "SAVE" for >2s a selection window opens up, in which the parameter value can be saved onto other zones simultaneously. See 5.3.4 Window: Saving to multiple zones</p>
	Return to previous window

5.3.4 Window: Saving to multiple zones

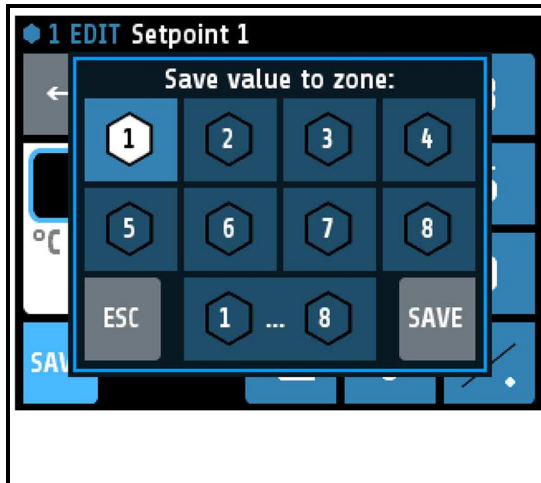

The zone (here 1) that now has to be saved is selected and cannot be deactivated.

By tapping the relevant zone field another zone can be added or deleted.

Black number on white symbol means "Zone chosen to be saved"

The lowest key "1...8" selects all zones at the same time.

"ESC" closes the window without saving.

"SAVE", saves the adjusted parameter value for all zones selected and closes the window.

5.3.5 Window: Setting text

This window is used to enter text for description of program names.



The header displays the actual program number and the actual program name.

By pressing the number keys „0 ... 9“ the new text can be entered. To set the following letters "ABC1" you have to press the key more times.

After one second the character is taken over and the next character can be entered.

In order to take over the new text, it must be saved by pressing the "SAVE"- key.



The new text is displayed in the blue/white frame.



Delete last character.



Delete all characters.



Key for setting the text. Repeated pressing changes to the next character. Here "A B C 2 Ä"



Switching case sensitive. Capital and small letters.



Return to previous window







Saving of the new text and return to previous window.

5.4 More display screens (more Windows)

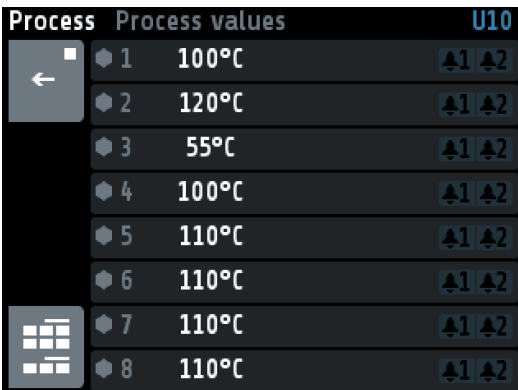
5.4.1 Window: Process





This window displays an overview of all zones.

	<p>Six columns display the following for all zones:</p> <ol style="list-style-type: none"> 1. Zone number 2. Actual Process Value (Proc[°C]) 3. Monitoring 1+2 (bell symbols)
	<p>Display of Monitoring 1 (2). Grey = signal not active. Coloured = signal active</p>
	<p>Hold down < 2 sec. = Return to previous window Hold down > 2 sec. = Jump to window "Actual Process Value"</p>
	<p>Jump to window "Main"</p>

5.4.2 Window: Graph

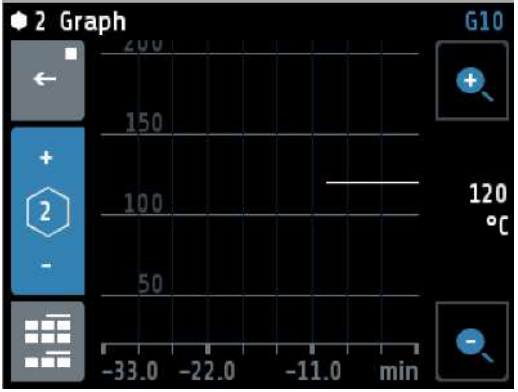



This window shows the temperature progression for one selected zone.

In the case of a technical incident the actual process value can still be examined afterwards.

	<p>On the right the actual process value is shown, here 120°C.</p> <p>By pressing the loupe keys "+" and "-" the resolution of the temperature axis can be altered.</p> <p>The time axis can be determined by the parameter "Graph sampling time" in the window "System/Settings".</p> <p>Turning off the device causes deletion of the values.</p>
	<p>"+" switchover to the next zone. Display of the current zone number " - " switchover to the previous zone.</p>
	<p>Hold down < 2 sec. = Return to previous window Hold down > 2 sec. = Jump to window "Actual Process Value"</p>
	<p>Jump to window "Main"</p>

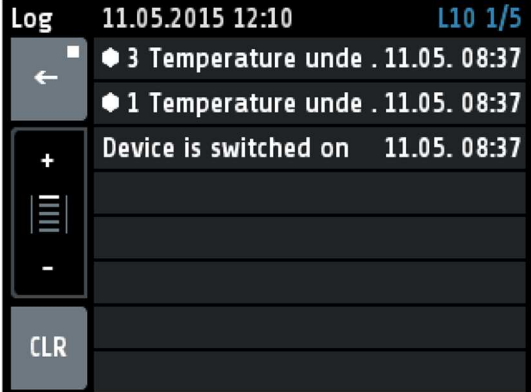
5.4.3 Window: Log (Logbook)

This window displays alarm- and status messages for all zones.

	<p>The header displays the current date and time, the window number and page.</p> <p>Pressing the log-texts displays the full text if it is abbreviated in the normal display. See also 1)</p> <p>The logbook can take up to 40 entries. The latest entry can be found on page 1/5. If 40 entries exist already, the oldest entry will be deleted.</p> <p>The logbook is stored in a power failure safe manner.</p>
	<p>Switching between the logbook-pages "+" previous page; "-" next page 1) Alternatively press the upper or lower areas of the list for switching pages. (Changeover only with a pushbutton pressure less than 1s, otherwise only long-text display without page switchover)</p>
	<p>Hold down < 2 sec. = Return to previous window Hold down > 2 sec. = Jump to window "Actual Process Value"</p>
	<p>Deletion of the logbook-entries</p>

5.4.4 Window: Parameter

This window is used as a display and input of all zone-parameters for all zones.

	<p>The header displays on the left the zone number and the window name, here "Main/Parameter".</p> <p>The selected parameter is displayed in the middle with light blue background. By pressing the +/- Buttons on the right (or pressing the upper or lower areas of the list) the list can slide up or down.</p> <p>Pressing the selected parameter will switch to a corresponding selection window.</p>
	<p>"+" switchover to the next zone. Display of the current zone number "-" switchover to the previous zone.</p>
	<p>Hold down < 2 sec. = Return to previous window Hold down > 2 sec. = Jump to window "Actual Process Value"</p>
	<p>Jump to window "Main"</p>

5.4.5 Zone – Parameter list

Zone On/Off	off	Measuring- or controlling zone switched off
	on	Measuring zone active <§>

5.4.5.1 Menu: Limit values		Adjustment of the limit values. It is necessary to set the limit configuration first. See: 5.4.6.2
Limit 1 min.	OFF(MRS) ... MRE	For absolute limits <§> = OFF
	-100 ... OFF(0)	For relative limits
Limit 1 max.	OFF(MRS) ... MRE	For absolute limits <§> = OFF
	OFF(0) ... 100	For relative limits
Limit 2 min.	OFF(MRS) ... MRE	For absolute limits <§> = OFF
	-100 ... OFF(0)	For relative limits
Limit 2 max.	OFF(MRS) ... MRE	For absolute limits <§> = OFF
	OFF(0) ... 100	For relative limits

5.4.5.2 Menu: Sensor settings		All parameters for sensor configuration
Sensor		Description see 0 Configuration sensors
Process offset	-999..0..1000°C	<§= 0°C> This parameter serves to correct the input signal: - the correction of a gradient between the measuring point and the sensor tip - line resistance balancing at 2-wire-RTD - Correction of the control deviation when using P or PD action. If for example the offset value is set to +5°C, then the real temperature measured by the sensor is 5°C less than the displayed actual process value. Make sure that the adjusted actual temperature value should not fall below or exceed the measuring range limits.
The minimal span of linear value min. and max. is 100, the maximal span is 2000.		
Linear value min. For linear measurement range only	-900 ... (Linear value max. -100)	Measuring range starting value of the linear scale. <§= 0>
Linear value max. For linear measurement range only	(Linear value min. +100) ... 10.000	Measuring range final value of the linear scale. <§= 1000>
Decimal For linear measurement range only	0 ... 2	Decimal of the linear measuring range. <§= 1>
Unit zone	°C ... °F	For control zones, you can choose between ° C and ° F. <§=°C> The temperature values of the selected zone are set to the specified unit with this parameter. Please check all temperature values after adjustment. (Limit values, setpoints, setpoint limits, actual value offset and, if applicable, the linear limits.)
	°C, °F, OFF, %, A, V, Hz, rpm, U/min, bar, psi, Pa, l/min, m ³ , l, m/s, m ² /s, kg, N, Nm, J, J/m ³ , s, min, h	Numerous units can be set in display zones. <§=OFF> No unit = OFF



5.4.5.3 Control outputs

Possible settings for the logic outputs and relay or continuous outputs.
This is used to determine which signal is sent to the output.

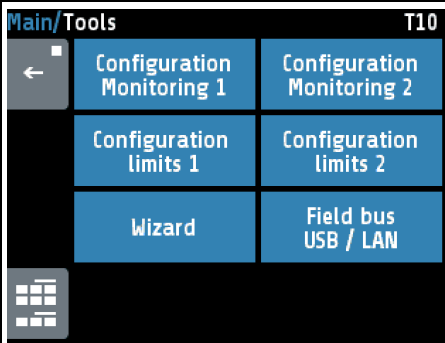

Conf. digital out	off	No function <§>
	Limit 1	Output of limit violation 1 to digital output x.
	Limit 2	Output of limit violation 2 to digital output x.
Conf. relay out	off	No function <§>
	Limit 1	Output of limit violation 1 to relay x.
	Limit 2	Output of limit violation 2 to relay x.
Continuous out configuration (Option)	off	No function <§>
	Current value	Output of the current value to the continuous output x (0..20mA or 0..10V)
	Current value live zero	Output of the current value to the continuous output x with offset zero. (4..20mA or 2..10V)
The minimal span of Continuous out min. and max. is 10.		
Cont. out min. For "continuous out configuration" = "Current value" only	MR-Start ... (Cont. out max. -10)	Starting value of the linear output. <§= 0> Corresponds to 0/4mA or 0/2V.
Cont. out max. For "continuous out configuration" = "Current value" only	(Cont. out min. +10) ... MR-End	Final value of the linear output. <§= 800> Corresponds to 20mA or 10V.

Copy all parameters	to zone	Transfer all zone parameters to another zone
Opens a window for selecting the zones into which the parameter values of the current zone shall be copied.		

5.4.6 Window: Tools

	<p>Pressing the configuration key leads to windows in which the associated parameters can be selected or set.</p> <p>Pressing the wizard key activates a guided setting help for the most important device parameters.</p>
	<p>Hold down < 2 sec. = Return to previous window Hold down > 2 sec. = Jump to window "Actual Process Value"</p>
	<p>Jump to window "Main"</p>

5.4.6.1 Configuration Monitoring 1+2

Settings for messages of monitoring 1. The same applies to monitoring (2).		
The indicator has two independent monitoring relays. With the help of the monitoring several events of the indicator can be routed (wired OR) to the relays.		
If the monitoring is active it is displayed by the bell symbols ( ). The colour of the symbols is programmable for the limit violations and fixed for all other events. In case of several events with different colours at the same time the priority of the colours is: red, orange, green.		
Limit 1	---	Not selected <§ for Monitoring2>
	One zone => Message	Once Limit 1 is active in one zone, monitoring 1(2) is set. <§ for Monitoring1>
	All zones => Message	Monitoring 1(2) is not set until Limit 1 is active in all zones.
Limit 2	---	Not selected <§ for Monitoring1>
	One zone => Message	Once Limit 2 is active in one zone, monitoring 1(2) is set. <§ for Monitoring2>
	All zones => Message	Monitoring 1(2) is not set until Limit 2 is active in all zones.
Sensor error Colour: red	---	Not selected <§ for Monitoring2>
	Active	In the case of sensor break monitoring 1(2) is set. <§ for Monitoring1>
System error Colour: red	---	Not selected <§>
	Active	Monitoring 1(2) is set, if system error occurred.
Moni 1(2) Relay	Direct	Relay switches on, if monitoring 1(2) is active. <§>
	Indirect	Relay switches off, if monitoring 1(2) is active.

5.4.6.2 Configuration Limit 1+2

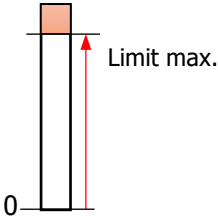
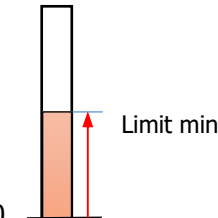
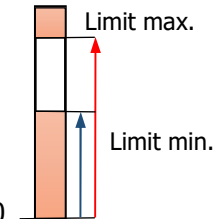
Settings for limit values min./max. and configuration of limit monitoring 1/2	
<p>The indicator features two independent limit monitors. These limit values can be output to the monitoring relays via the monitoring function (0). Irrespective of this, the limit value overruns can be output on the zone relays or logic outputs. In the case of sensor and line errors, the limit value violations react in the same way as range over-ride.</p>	
<p>Desired function</p> <p>Limit exceeded.</p> <p>The actual value must be greater than the absolute limit max. for the limit monitor to become active.</p>	<p>Absolute limit alarm</p> 
<p>Falling below the limit.</p> <p>The actual value must be smaller than the absolute limit min., so that the limit value monitoring becomes active.</p>	
<p>Double-sided limit monitoring.</p> <p>The actual value must be outside the range for the limit value monitoring to become active.</p>	

Limit values min/max	Limit value 1 / 2 (min.)	MB-Start<§> ... MB-End
	Limit value 1 / 2 (max.)	MB-Start<§> ... MB-End
Delay	OFF	Limit delay switched off. <§>
	1 ... 8000 s	Limit event is delayed by the selected time.
Self-retaining	off	No self-holding of the limit alarm. <§>
	on	An activation of the limit violation will be stored. The limit violation can be acknowledged in the window "Monitoring".
Start suppression	OFF Without start up	Start-up suppression switched off <§>
	Start up Suppression active	Start-up suppression active: The actual value must be within the limits once. Only then, a limit violation triggers the monitoring.
Display colour	Red	Monitoring displays the limit violation in red colour. <§>
	Green	Use as an enable signal: Display colour is green.
	Orange	Display colour is orange.

5.4.6.3 Field Bus / USB / LAN

Menu: Fieldbus		It depends on the installed field bus module what parameters will be visible.
Protocol	off	No protocol selected
	Elotech	<SERIAL> ELOTECH-Standard-protocol
	Modbus	<SERIAL> Modbus-RTU-protocol
	Arburg 1	<SERIAL> Hot runner: One device address for all zones.
	Arburg 2	<SERIAL> Hot runner: Every zone has its own address.
	Arburg 3	<SERIAL> Protocol for temperature control systems
	Profibus DP	<PROFIBUS> Profibus DP
Status		
Display only	---	<SERIAL> No data communication
	Data Exchange	<SERIAL> Data communication is active <PROFIBUS> Data-Exchange-Mode
	Wait Param	<PROFIBUS> Indicator waits for configuration / parametrisation
	No connection	<PROFIBUS> No master connected / Master not active
Baudrate		
<SERIAL>	1.2 kBaud	1.200 Bit/s
	2.4 kBaud	2.400 Bit/s
	4.8 kBaud	4.800 Bit/s
	9.6 kBaud	9.600 Bit/s <§>
	19.2 kBaud	19.200 Bit/s
	38.4 kBaud	38.400 Bit/s
Baudrate <PROFIBUS>	Display only	45,5 kBaud – 12Mbaud (forced by the master) Not detected = no master connected
Address		
	1 ... 255	1<§> ... 255 (ELOTECH-Standard) 1<§> ... 247 (Modbus-RTU-Protocol) 1<§> ... 32 (Arburg-Protocols) 2<§> ... 125 (Profibus) At this address a master communicates with the indicator. Each indicator needs a unique address.
Format		
<SERIAL>	7 E 1	7 Data bits, 1 Stop bit, Parity Even <§>
	7 O 1	7 Data bits, 1 Stop bit, Parity Odd
	7 E 2	7 Data bits, 2 Stop bits, Parity Even
	7 O 2	7 Data bits, 2 Stop bits, Parity Odd
	7 N 2	7 Data bits, 2 Stop bits, Parity None
	8 E 1	8 Data bits, 1 Stop bit, Parity Even
	8 O 1	8 Data bits, 1 Stop bit, Parity Odd
	8 N 1	8 Data bits, 1 Stop bit, Parity None
	8 N 2	8 Data bits, 2 Stop bits, Parity None
HW-config		
<SERIAL>	The serial fieldbus module has three integrated interfaces. Select here the desired interface:	
	RS232/RS485	Signals see connection diagram.
	TTY	Signals see connection diagram.
Remote		
<PROFIBUS>	On	Profibus can read and write. Local operation is locked.
	Off	Profibus can read only. Local operation is permitted. <§>

Menu: USB		Save indicator data on an USB-Stick. (USB-flash drive) The data is stored as a text file in an adjustable CSV-format. The USB-flash-drive must be formatted with FAT. (FAT16/ FAT32) The file name contains the last 5 digits "xxxxx" of the MAC-ID.
Save to USB	All parameters	Save all parameters for all zones. Generates the file -> LogParaxxxxx.txt and LogPara.bin
	Al. Logbook	Save the entries of the Alarm Logbook. Generates the file -> LogBookxxxxx.txt
	Graph	Save the measuring points of the graph for all zones. Generates the file -> LogGraphxxxxx.txt
USB status		
	- - -	Display of the USB-status: no stick detected.
	Key detected	USB-stick detected: Files can be saved or loaded from the USB flash drive.
Load		
	Load all Parameters	Loading a previously saved parameter set. The file "LogPara.bin" must exist on the USB flash drive.
Separator		
	none <§>	Delimiter symbol between single data sets: Spaces
	comma	,
	semicolon	;
	colon	:
	tabulator	<TAB>
Sample-Interval		
	OFF; <§> 5...720s	Cycle time for writing an output line with time stamp on the USB stick.
<p>If the parameter "Log interval" is set to a numerical value, so a file named "LogA4000_xxxxx_YYYY_MM_DD.txt" is generated on the USB stick. "xxxxx" the last 5 dig- its of the MAC-ID. YYYY, MM and DD mean the year, month, day. After a change of date a new file is created.</p> <p>With the included names MAC-ID "xxxxx", the files can be assigned to different A4000 indi- cators.</p> <p>Each "Log interval" time a new row is added. The line includes a time-stamp and the actual value of zone 1 to zone x.</p>		

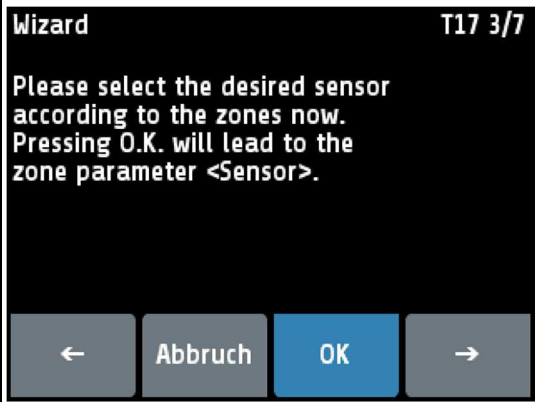

Menu: LAN		Ethernet interface for connection to the configuration tool ELO-Vision 3 or for a MODBUS-TCP communication.
IP-address 1		IP-Address 192 . 168 . 100 . 100 Part 1 <§>
IP-address 2		IP-Address 192 . 168 . 100 . 100 Part 2
IP-address 3		IP-Address 192 . 168 . 100 . 100 Part 3
IP-address 4		IP-Address 192 . 168 . 100 . 100 Part 4
Subnet mask		
Subnet mask 1		Subnet mask 255 . 255 . 255 . 0 Part 1 <§>
Subnet mask 2		Subnet mask 255 . 255 . 255 . 0 Part 2 <§>
Subnet mask 3		Subnet mask 255 . 255 . 255 . 0 Part 3 <§>
Subnet mask 4		Subnet mask 255 . 255 . 255 . 0 Part 4 <§>
Default gateway		
def.-gateway 1		Default gateway 192 . 168 . 100 . 1 Part 1 <§>
def.-gateway 2		Default gateway 192 . 168 . 100 . 1 Part 2 <§>
def.-gateway 3		Default gateway 192 . 168 . 100 . 1 Part 3 <§>
def.-gateway 4		Default gateway 192 . 168 . 100 . 1 Part 4 <§>
MAC ID	549A11:5xxxxx	Display of the MAC-ID: 54:9A:11:5x:xx:xx

5.4.7 Wizard

	<p>The wizard serves as a support for initial commissioning of the indicator or in the occasion of a re-configuration.</p> <p>Please notice the wise order in which the parameters of the wizard must be adjusted. The wizard can be cancelled at any time. By pressing the arrow keys, you will move on to the next step. Pressing the OK key will lead to the parameters.</p>
---	---

New indicators automatically start with the wizard. After pressing "finish" in the last window of the wizard the wizard will not be shown anymore at start-up.

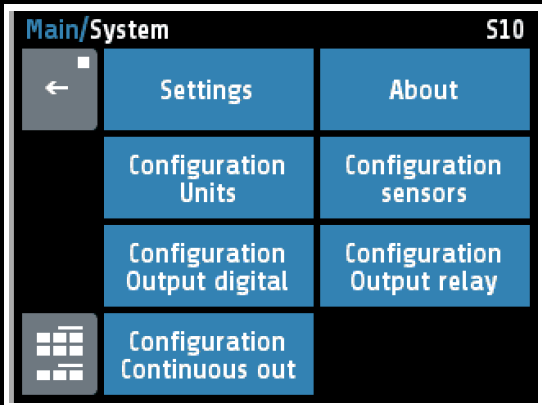
5.4.8 Window: System

	<p>Pressing the configuration key leads to windows in which the associated parameters can be selected or set.</p> <p>Pressing the key "About", shows hardware information of the indicator.</p> <p>The "Configuration continuous out" menu appears only for indicators with the option "continuous". The relay outputs are lost in this case.</p>
	<p>Hold down < 2 sec. = Return to previous window Hold down > 2 sec. = Jump to window "Actual process value"</p>
	<p>Jump to "Main"</p>

5.4.8.1 Settings

Language	Deutsch (German)	German <§>
	English (English)	English
Authorisation (LOC)	All Parameter adjustable	All parameters adjustable <§>
	clock adjustable	Time/date is adjustable. All other parameters are locked.
	All parameters locked	No parameter is adjustable
	Change Lock code	Here the code (start value = 0000) can be changed to a different value.
<p>The old code is requested before the setting of the new code. The new Code has to be entered twice. The parameters that have been locked can be displayed but not changed. This parameter cannot be changed if the logic input In_2 is active, or the lock code is not known. The value of the factory setting is <§ = 0000></p>		
Clock, Time, Date		
Time	Hours	Number value 0 ... 23
	Minutes	Number value 0 ... 59
Day / Month	Day	Number value 1 ... 31
	Month	Number value 1 ... 12
Year	2000 ... 2150	Adjustment of calendar year
Sample rate	Time interval between the current measurements of two successive zones. In brackets the complete time interval as shown on display:	
Scanning time for recorder function	2,5 s (Total time: 8,2 Min) 5 s (Total time: 16,5 Min) 10 s (Total time: 33 Min) <§> 30 s (Total time: 99 Min) 1 Min. (Total time: 3,3 h) 5 Min. (Total time: 16,5 h) 10 Min.(Total time: 33 h) A maximum of 198 temperature points can be saved.	
Zone offset	OFF	<§>
	1 ... 91	The adjusted offset value is added to the displayed zone numbers in the windows. Therefore a continuous numbering of the zones can be achieved if more than one device is used. Examples: Offset= OFF: Zone numbering: 1-8 Offset= 4: Zone numbering: 5-12
Zone numbers	Visible only when zone offset is off.	
Zone 1...8	OFF; 1...99	<§>OFF With this parameters, individual numbers can be assigned to the zones. In all windows these values are displayed, instead of the real zones.

5.4.8.2 About / → Firmware update

Firmware	Displays the current firmware and language version.
Firmware update	<p>Start the firmware update by selecting the button "Start Update" and confirm with SAVE. A confirmation prompt opens. If this window is confirmed with YES, the unit turns into the loader mode.</p> <p>When the loader mode is accidentally turned on, you can switch back by a mains reset into the existing user program.</p> <p>If an update should be performed, a USB flash drive must be plugged in with the new firmware. After a short time, the firmware folder appears in the line "Folder". E.g. „EL4000.01_V20xx_xx.ELO".</p> <p>Now you can start the loading process by touching the touch screen. The indicator must not be disconnected from the power supply until the download is complete! After finished loading the new user program is started by a power interruption.</p>
Type A4000-0-x-x-000-0x-5	Type key of the indicator
Factory setting	Reset to factory delivery status. With the help of this parameter, all settings are deleted and reset to the delivery status. Choose "Reset", then press "SAVE".
Type R4010-0-x-0-000-00-5	Only with zone extension 12 or 16. Type code of the additional module.
Zone extension	(Only available for the 8-zone version) off <§> 12: Extended to 12-zone indicator. Requires additional module R4010-04 16: Extended to 16-zone indicator. Requires additional module R4010-08

5.4.8.3 Configuration Units

For each zone, the unit to be displayed can be selected here. In case of control zones, the unit can be °C or °F, for indicator zones, additional unit (OFF),%, A, V, Hz, rpm, rpm, bar, psi, Pa, l/min, m³, l, m/s, m²/s, kg, N, Nm, J, J/m³, s, min or h can be selected.

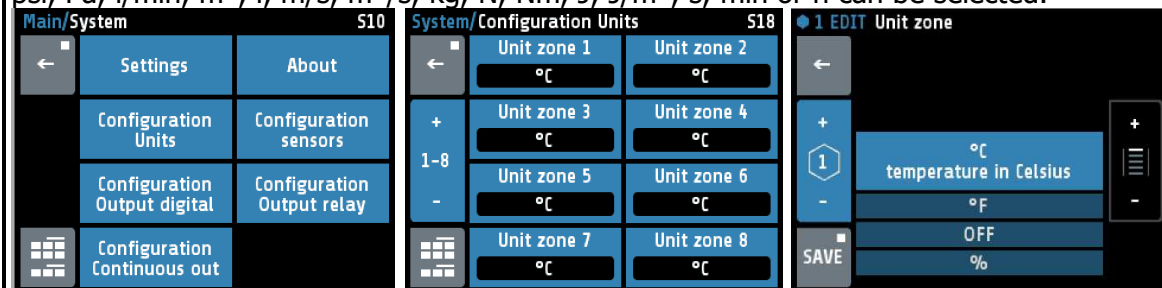

Unit zone	Description see at 5.4.5.2 Menu: Sensor settings Unit zone
------------------	---

5.4.8.4 Configuration sensors

Sensor	Linear 0...10 V	Voltage 0 to 10 V
	Linear 0...20 mA	Current 0...20mA
	Linear 4...20 mA	Current Live Zero 4...20mA
	PT100 2-wire	Pt 100 (RTD) 2-wire connection -100...800°C
	PT100 3-wire	Pt 100 (RTD) 3-wire connection -100...800°C
	Ni120 2-wire	Nickel 120 2-wire connection 0...250°C
	Ni120 3-wire	Nickel 120 3-wire connection 0...250°C
	(TC) Fe-CuNi (J)	Thermocouple Type J 0...800°C
	(TC) NiCr-Ni (K)	Thermocouple Type K 0...1200°C
	(TC) Fe-CuNi (L)	Thermocouple Type L 0...800°C
	NiCrSi-NiSi (N)	Thermocouple Type N 0...1200°C
	(TC) PtRh-Pt (S)	Thermocouple Type S 0...1600°C
Please NOTE : If the sensor selection is changed, the following parameters will be reset:		
	Setpoint 1, Setpoint 2: Lower setpoint limitation: Highest setpoint limitation: Setpoint ramp rising/falling: Limit values: Actual process value offset: Setpoint softstart: softstart:	Setpoint limitation min. Measuring range bottom Measuring range top off off off 100°C off

5.4.8.5 Configuration Output digital

A digital output (logic output) is available for each zone. Select the desired output signal. Configurations that are not possible are not displayed. Like "cooling" in this example.



Digital 1 ... x | Description see 5.4.5.3 Control outputs

5.4.8.6 Configuration Output relay

For every zone one relay output is available. Select the desired output signal.

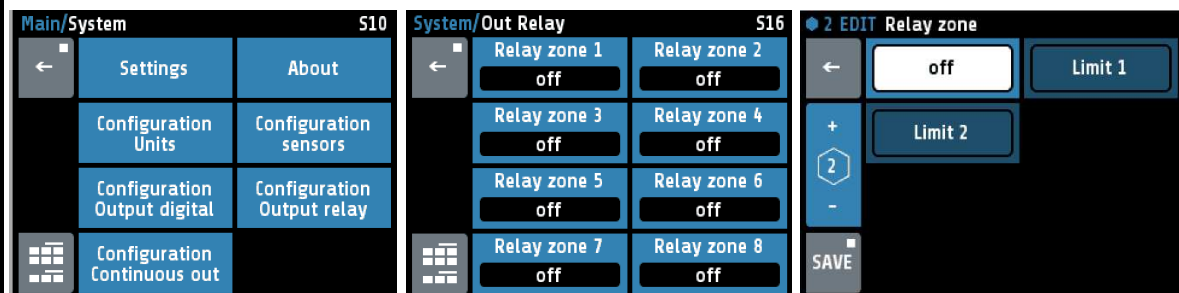

Relays 1 ... x | Description see 5.4.5.3 Control outputs

5.4.8.7 Configuration of continuous outputs (option)

A continuous output is available for each zone. Select here the desired output signal.

Main/System 510		System/Continuous output 517		9 EDIT Continuous	
←	Settings	←	Continuous 9 Current value	Continuous 10 off	← off Current value
	Configuration Units		Continuous 11 off	Continuous 12 off	+ Current value LZ live zero
	Configuration Output digital		Continuous 13 off	Continuous 14 off	9
	Configuration Continuous out		Continuous 15 off	Continuous 16 off	-
					SAVE

Continuous 1 ... x Description see 5.4.5.3 Control outputs

6 Error Messages

Error message	Cause	Possible remedy
At actual process value maximum value flashes	Top range end has been exceeded, sensor defect	Check sensor and cable
At actual process value minimum value flashes	Bottom range end has been exceeded, sensor defect	Check sensor cable Check process value offset TC connected with inverted polarity
REMOTE: Parameter locked	Adjusting of parameters is not allowed. Device is controlled by fieldbus.	Profibus: The parameter "Remote" in the menu Field bus is set to "on".
EloVision is active!	Adjusting of parameters is not allowed. Device is controlled by EloVision.	The configuration-tool EloVision is active. Please close EloVision, or switch to the visualisation page of von EloVision.
Field bus module unavailable		The indicator is not fitted with the correct hardware for the selected protocol.
DfErr	Text display error	Please send the indicator back to the manufacturer.
ERR0	System error	Please send the indicator back to the manufacturer.
ERR8	System error	Quit error message. Check the parameters. If the error is still there, send the indicator back to the manufacturer.
ERR IO	Error I/O board See logbook: Error IO board 1 or 2 Error IO board 3 or 4	The connection to the input/output circuit board is broken. -> Internal card defective, please send the indicator back to the manufacturer. -> If zone extension (0 menu About) is set to 12 or 16, the required additional module R4010 may not be connected. Switch off zone extension if necessary. <i>Info: All 4 sensors of the faulty card are set to sensor break.</i>

7 Technical Data

Input Pt100 (DIN)	2- or 3- wire connection possible Built-in protection against sensor breakage and short circuit Sensor current: ... < 1 mA Accuracy: ... < 0,2 % Linear error: ... < 0,2 % Influence of the ambient temperature: ... < 0,01 % / K
Input Thermocouple	Built-in internal compensation point and protection against sensor breakage and incorrect polarity. Accuracy: ... < 0,25 % Linear error: ... < 0,2 % Cold junction error: 0,5K Influence of the ambient temperature: ... < 0,01 % /
Input voltage 0...10V	Internal resistance > 100 k-Ohm Accuracy: < 0,25 % Linearity error: < 0,2 % Ambient temperature influence: < 0,01 % / K
Input current 0...20mA	Internal resistance < 100 Ohm Accuracy: < 0,25 % Linearity error: < 0,2 % Ambient temperature influence: < 0,01 % / K ! The input has high impedance when the indicator is without supply voltage.
Logic input	Internal resistance > 22k-Ohm Level 0 < 2V Level 1 > 9V; max 30V
Logic outputs	Bist. voltage, 0/24 V DC, max. 500 mA, short-circuit proof
Relay outputs/ Alarm outputs	Relay; max. 250V AC, max. 2A, resistive load
Continuous outputs	0...20 mA maximal load 300 Ohm; 0...10V minimal Load 5kOhm. Automatic switching, depending on connected load.
Fieldbus Interface:	Depends on the version of the device: - Serial: RS232, RS485, TTY (20mA) - Profibus DP, according to EN 50170 All with optical isolation.
Service-Interface	Ethernet: Modbus TCP
USB-Interface	Host for USB-Stick; max. 100mA
Supply voltage	24 V DC, +/-25 %, appr. 6W + Power of logic outputs
LCD-Display	8,8 cm (3,5") RGB-display with LED-backlight. 320 x 240 pixel with resistive Touch-Panel
Data protection	EAROM, Semiconductor storage When using a Fieldbus interface please note: Permissible writing operations per parameter must not exceed 1 000 000.
Casing	Format, case: 96x96mm, acc. DIN 43700, Installation depth 122 mm Panel cut-out: Width=92 +0,5 mm x Height=90 +0,5 mm Material: Sheet steel and Makrolon UL 94-V1 Protection mode: IP 20 (DIN 40050), Front side: IP 50

Connectors	Service-Interface: Ethernet RJ45 USB-Interface: Type A Profibus: SUB-D 9 Others: spring-loaded push terminals, Protection mode IP 20 (DIN 40050), Insulation class C Cross-sections: Terminal groups: A, B, D, E, F, G, I, K, M, N, Q + C, H (continuous) = 1,5 mm ² (for end sleeves with plastic collar 0,75mm ²) Terminal groups: C, H, (Relay), P = 2,5mm ²
Real time clock	Backup battery: Lithium CR2032
Weight	Approx. 800g, depends on the version of the device
E-Bus	Bus system for connecting the A4000 to the extension module R4010, to expand the number of zones to 12 or 16 zones. Serial bus. The connecting cable must be shielded.
Permissible operating conditions	Operating: 0...50°C / 32...122°F Temperature: -30...70°C / -22...158°F Storage temperature: KWF DIN 40040; equivalent to annual average Climate class: max. 75% rel. humidity, no condensation
CE - mark	EN 61326-1:2013 / EN 61000-3-2:2006+A1:2009+A2:2009 EN 61000-3-3:1995+A1:2001+A2:2005 Electrical safety: EN 61010-1

Subject to technical improvements.